

These measurements refer to the frame work and do not include upholstery, seam or zip

Tolerances (mm)			
Dimension			Deviation
(1)	-	20	±0,2
(20)	-	50	±0,5
(50)	-	200	±1,0
(200)	-		±2,0

Side screen (left + right)

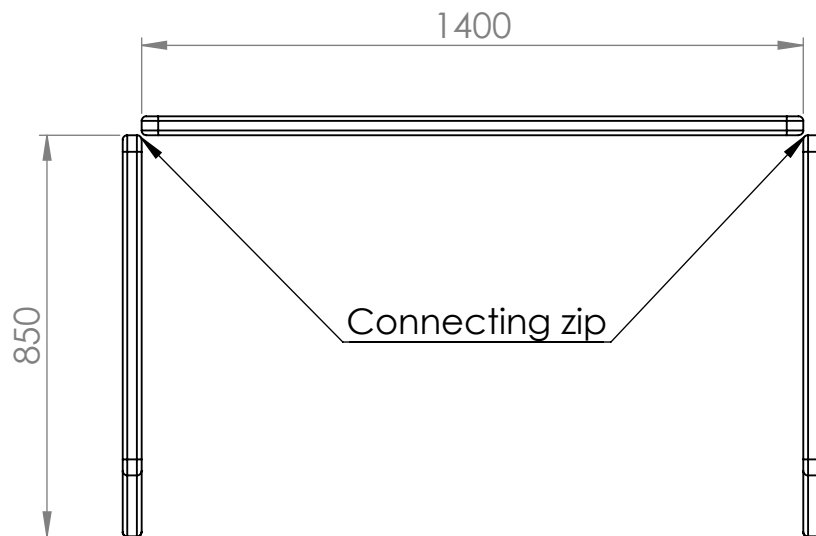
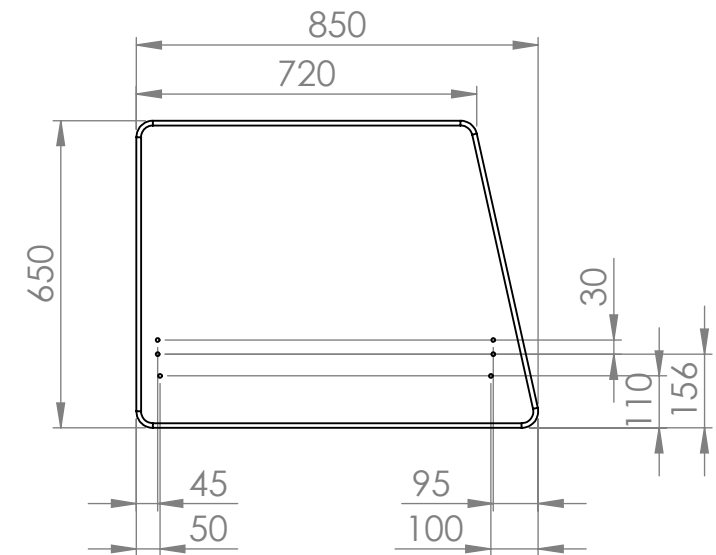
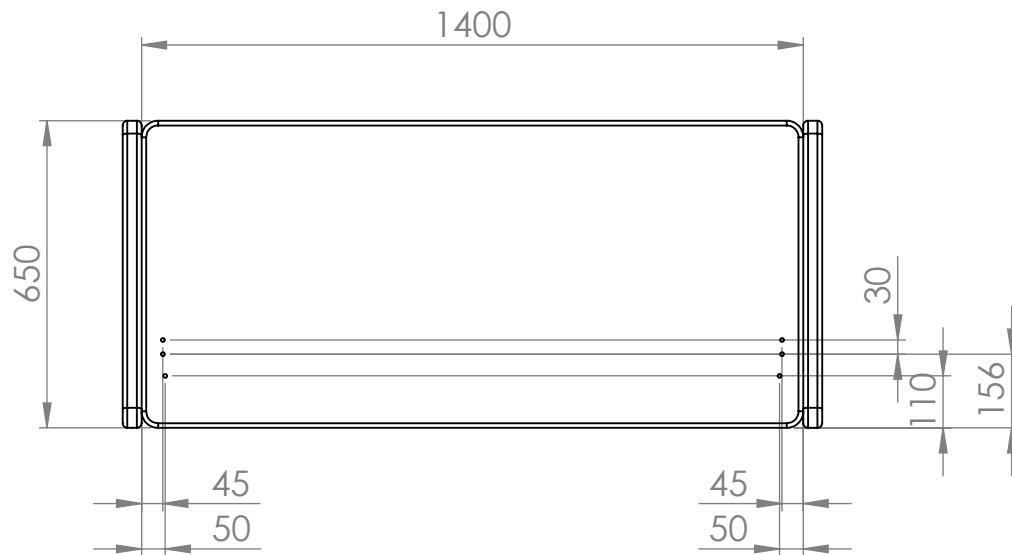

Section view of ScreenIT A30

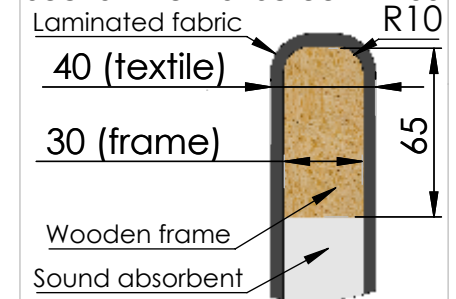

Art.Nr. 108140		Name ScreenIT A30 Desk booth Peak 1400x650		
Last saved by Angelica	Last saved 2019-10-03	Material	Rev -	Format A4
Created by Angelica	Created date 2019-10-02		Scale 1:16	Page 1/1