

Section view of ScreenIT A30

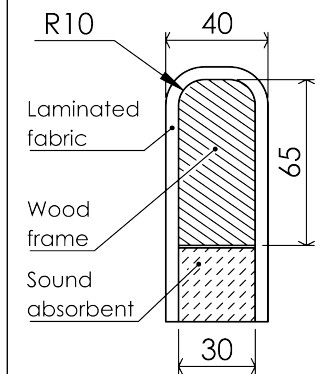

© 2024

GÖTESSONS

Art.nr.
6430805

Name
ScreenIT A30 800x650 mm
500 mm above table

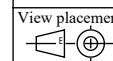

General tolerance
SS-ISO 2768-1
m

THESE MEASUREMENTS
REFER TO THE FRAMEWORK
AND DO NOT INCLUDE
UPHOLSTERY, SEAM OR ZIP

Material
X

THIS DRAWING AND INFORMATION CONTAINED HEREIN ARE THE PROPERTY OF
GÖTESSONS DESIGN GROUP AB AND SHALL BE RETURNED UPON DEMAND
AND SHALL NOT BE REPRODUCED IN WHOLE OR IN PART TO ANYONE ELSE OR
USED WITHOUT WRITTEN CONSENT OF GÖTESSONS DESIGN GROUP AB

Rev
A

Format
A4

Scale
1:10

Page
1/1